

COMPOSITE

# MMT-101/01

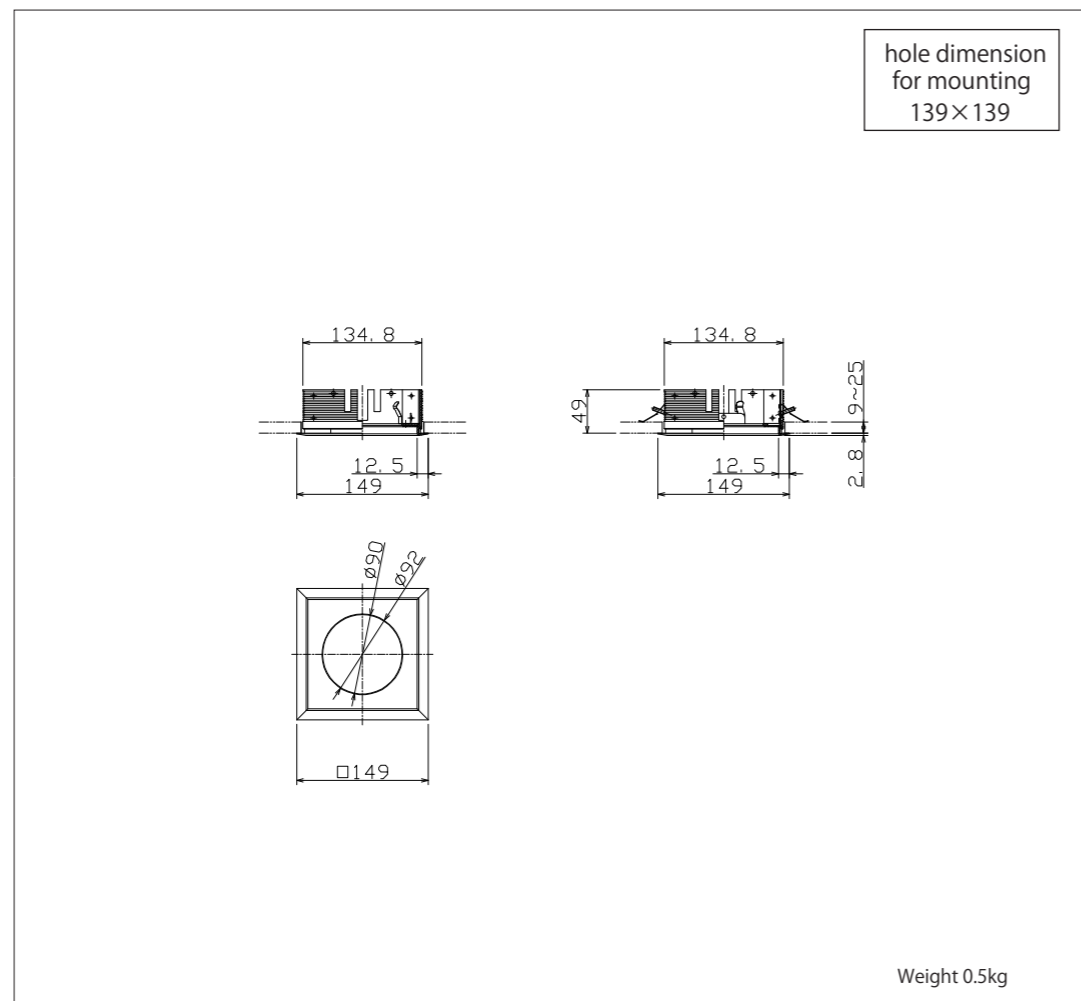
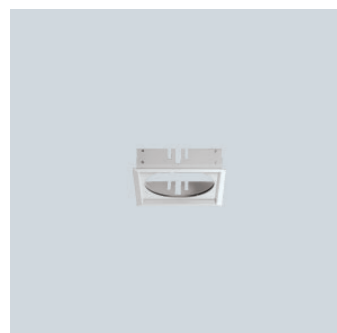

# ModuleX

To install the fixture safely 《 Read carefully and follow all the instructions in the guide 》

⚠ Warning : Failure to install the fixture properly could result in personal injury.		⚡ : Prohibited
⚠ Caution : Failure to install the fixture properly could result in property damage.		⚠ : Strict observance
Before installation	⚠ Warning  ⚡  ⚠ Caution	<p>The fixture is for indoor use only in general conditions. Can not be used following conditions (Causes of falling, electrocution and fire)</p> <ul style="list-style-type: none"> <li>● Inclined, uneven surface</li> <li>● High humidity</li> <li>● Outside</li> <li>● On the floor</li> <li>● Vibrated or shocked areas</li> <li>● Areas get direct sunlight</li> <li>● Insulated inside of ceiling</li> <li>● Ceiling which can't hold the fixture weight</li> <li>● On the wall</li> <li>● Places affected by wind or air-conditioner machine</li> <li>● Near fire</li> <li>● Dusty areas, corrosive gas outbreaks areas</li> <li>● Ambient temperature under 0°C and over 35°C</li> </ul> <p>Please contact if you are not able to judge whether installation environment is suitable to the places or not.</p> <div style="text-align: center;"> </div>
At lighting fixture installation	⚠ Warning  ⚡  ⚠ Caution	<ul style="list-style-type: none"> <li>⚠ Please follow the fixtures' instruction or this guide to install the fixture and lamp. (Causes of falling · electrification · fire)</li> <li>⚠ Make sure to install all the parts of fixtures besides installation and mounting parts will not touch with any objects both inside and outside of ceiling such as lighting track, etc. (Causes of falling · electrification · fire)</li> <li>⚡ Do not dismantle or remodel fixtures. (Cause of electrification · fire · falling · broken fixtures)</li> <li>⚠ Make sure the construction will not affect any fire prevention systems such as sprinkler by heat from the fixture. (Causes for improper operation)</li> </ul>

MMT-101/01

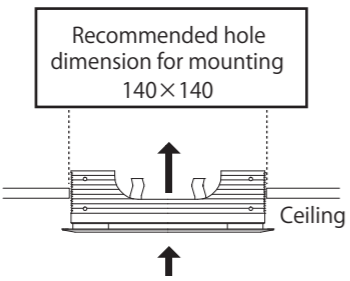
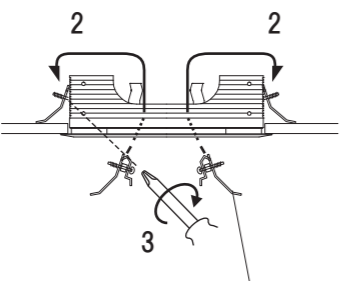
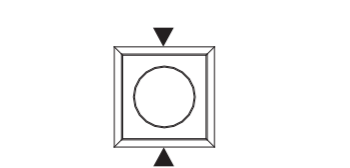
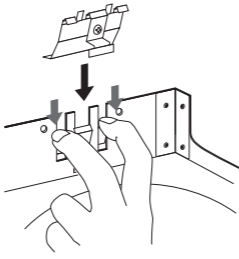
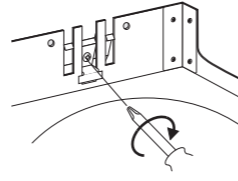
Installation Details		Installation Diagram	Caution	
1	Install the mounting equipment for ceiling cut out	<p>1 Ceiling cut out</p> <p>Recommended hole dimension for mounting 140×140</p>  <p>2</p>  <p>3</p>  <p>Attachment bracket is required in 2 facing sides of the box.</p>	⚠ a	⚠ b
2	Cut out a hole and install the mounting frame		 <p>Push tight</p>	 <p>Standard to screw torque 1.0~2.0N · m</p>
3	Slide the metal fittings from upper side			
	Use a screw driver and tighten the metal fittings			
⚠ a	On step 2, please fix the metal fitting firmly with your fingers. If not, it may cause falling of fixtures			
⚠ b	make sure to tighten the metal fittings securely with a screwdriver. (torque 1.0 ~2.0 N · m) If it is loose, it may cause falling of the fixture			

(Contact)

**Concord Lighting**

5/F, Longbow House, 14-20 Chiswell Street, London, EC1Y 4TW, UK  
Tel : +44-01273-616649

(Manufacturer)

**ModuleX Inc.**

#21 AraiBldg, 1-20-6 Ebisu-Minami Shibuya-ku, Tokyo  
Tel : +81-3-5768-3131